



Installation and Operating instructions

(Translation of the original installation and operating instructions)

TEKA suction crane



Table of contents

1. General	3
2. Description	4
2.1. Functionality	4
2.2. Intended use	4
3. Safety instructions	5
3.1. Definition of the hazard symbols	5
3.2. General safety instructions	5
4. Storage, transport and installation	6
5. Commissioning	7
5.1. Installing the wall consoles	7
5.2. Mounting the outer wall bracket	8
5.3. Mounting of the telescope arm	9
5.4. Mounting the pipe bend	9
5.5. Mounting the pipes on the wall bracket	9
5.6. Mounting the hoses on the wall bracket	10
6. Maintenance	12
6.1. Reset to maintenance state	12
6.2. Readjusting of the extraction hood	12
6.3. Readjusting the wall bracket joint	13
6.4. Relubrication of the wall bracket joint	13
6.5. Inspecting the fixing test of the wall console	13
6.6. Inspecting the fixing and functioning of the wall bracket	14
7. Dismantling / Disposal	15
8. Diagnostics and troubleshooting	15
9. Technical data	15
10. Maintenance intervals	16
10.1. Usage-related maintenance	16
10.2. General maintenance	17
10.2.1. Visual inspection of the suction crane	17

1. General

Congratulations on purchasing the product from TEKA.

Our engineers ensure that our devices reflect the state of the art through continuous development. Nevertheless, misuse or misconduct can endanger your safety. Please observe the following for a successful use of the device:

	<p>Only authorised and instructed personnel can carry out transport, operation, maintenance and repair of the device. The operator must ensure that the operating personnel take note of these instructions.</p> <p>Please read these instructions before operating the device, and observe the safety precautions to avoid injury!</p> <p>Store this manual in a safe place! These instructions are to be regarded as a component of the product!</p> <p>Adhere to all product notes!</p> <p>Modifications or conversions that the operator carries out at the device without the consent of the manufacturer, can lead to new safety hazards or to the loss of warranty claims.</p> <p>Observe the manufacturer's instructions. Contact the manufacturer in case of any uncertainty: Tel: +49 2541-84841-0 E-mail: info@teka.eu</p>
---	---

2. Description

2.1. Functionality

The suction crane can be set by the user in any desired position within his range and can be adjusted using the smooth-running joints.

The particles produced during welding, for example, are drawn off by the extraction hood and taken away by the hose leading to the connected suction unit.

The extraction hood must track the welding seam, possibly taking advantage of the thermally induced welding fume movements.

CAUTION However, it is important to ensure that connections between the workpiece and the extractor hood (and generally between the workpiece and filter device) are avoided, so that, if necessary, the welding current cannot flow back through the protective conductor of the filter device to the welding machine.

2.2. Intended use

The suction crane is primarily used for the localized extraction of smoke, gases, fumes and dust. The suction crane is connected directly to an extraction blower or a suction unit or a suction line.

	WARNING
<p>Improper use can damage parts and be a danger to life and limb!</p> <p>The suction crane must not be used for the extraction of:</p> <ul style="list-style-type: none">- damp, liquid or vapour-like materials,- smouldering or burning substances (including cigarettes),- gases / materials outside a temperature range from -30 °C to +100 °C.- gases or materials that are potentially explosive,- substances crystallising out in layers that are impermeable to air,- substances that are sticky or which cling due to static, or- materials that create sparks.	

3. Safety instructions

3.1. Definition of the hazard symbols

The suction crane is constructed according to the state of the art and the recognised safety regulations. Nevertheless, during use threats to life and limb of the user or other persons may arise. The impairment of the machine or other property are also possible. In these instructions we warn by using corresponding indications.

	WARNING
	WARNING These instructions are made in case of risks that can lead to <u>injury or death</u> .

	CAUTION
	CAUTION These instructions are made in case of risks that can lead to <u>injury</u> .

	NOTICE
	NOTICE These instructions are made in case of risks that can lead to <u>material damages</u> .

	Information notes are no hazard warnings; they call attention to useful information.
---	--

3.2. General safety instructions

	WARNING
	Dangers arising from improper use / unauthorised operations. The operator must ensure that their authorised personnel are familiar with all the safety indications in this manual in advance. The operator is responsible for ensuring that all work is carried out by authorised and qualified personnel.

4. Storage, transport and installation

	WARNING
<p>Risk of injury arising from the falling of the suction crane mounted to the wall. The suction crane must be firmly mounted to the destined wall. The wall must be vibration-free and vertical. The operator must check if the wall provides a sufficient bearing capacity.</p> <p><u>Static instructions:</u></p> <p>When used properly, a torque of up to 7.500 mm can occur at the wall bracket of a TEKA suction crane. Therefore, the underground intended for the assembly of the suction crane has to be examined critically if it is suitable for such a static load.</p> <p>We recommend the fixation at:</p> <ul style="list-style-type: none">• a concrete column. Attention: Use heavy-duty dowels or drill completely through the column and insert an appropriate counter-plate.• a steel column. Use appropriate machine screws M 12.• concrete walls. Use heavy-duty dowels. <p>If you want to fix it to a brick wall, check carefully whether it can absorb the additional load. In a critical case, we recommend to use bolts that run through the wall and a counter-plate.</p> <p>If there is no appropriate underground, the crane can also be fixed at one of the following constructions:</p> <ul style="list-style-type: none">• Free-standing column. The ground plate (minimum thickness of 10 mm) has to be anchored sufficiently to a concrete floor. The height of the column depends on the assembly height of the suction crane. If you also want to assemble a filter unit, refer to the corresponding operating instructions for the assembly height.• Continuous column. From the ground up to the ceiling. The cross-section has to be designed according to the length of the column.• Ceiling assembly. The crane is fixed at steel girders or at a concrete ceiling.	

	NOTICE
<p>Damage or functional impairment of the unit due to climatic influences. The unit must be stored in a dry place and protected against moisture during transport. As a matter of principle, the filter unit is not designed to be installed outside.</p>	

5. Commissioning

	WARNING
<p>Dangers arising from a defective condition of the unit. Make sure that the measures described in this chapter are completed before the commissioning of the unit. All required connections must be attached before turning the unit on. Do not operate the unit if any components are defective, missing or damaged. Check the orderly condition of the unit before switching it on.</p>	

5.1. Installing the wall consoles

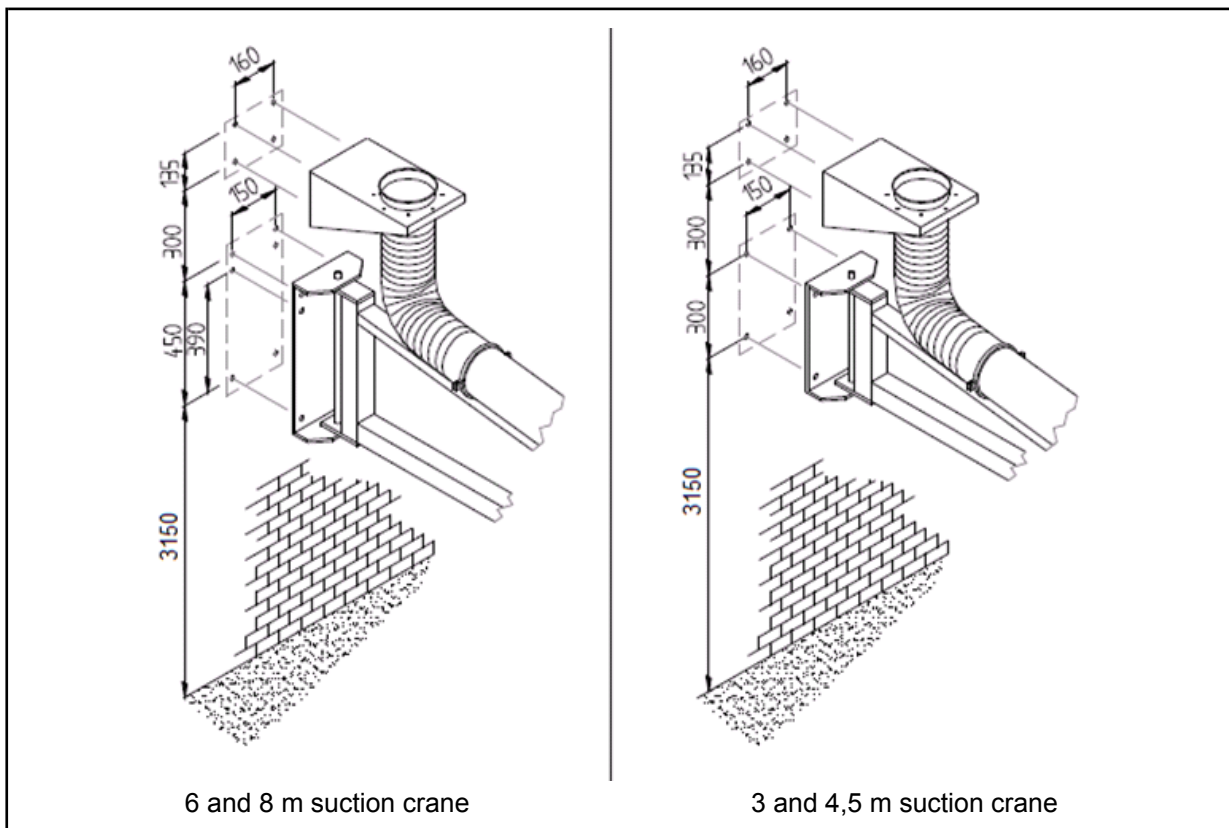

We recommend determining the assembly height of the suction crane as follows:

- Mark and drill the fixing holes as it is shown in the images.
- Fix the wall consoles by means of 12 mm thick bolts and align it exactly vertically. To this end, insert the later bearing bolt and control its pitch to one side and to the front with the help of a water level. Put metal sheets underneath the bracket if necessary to smooth uneven conditions in the wall.

5.2. Mounting the outer wall bracket

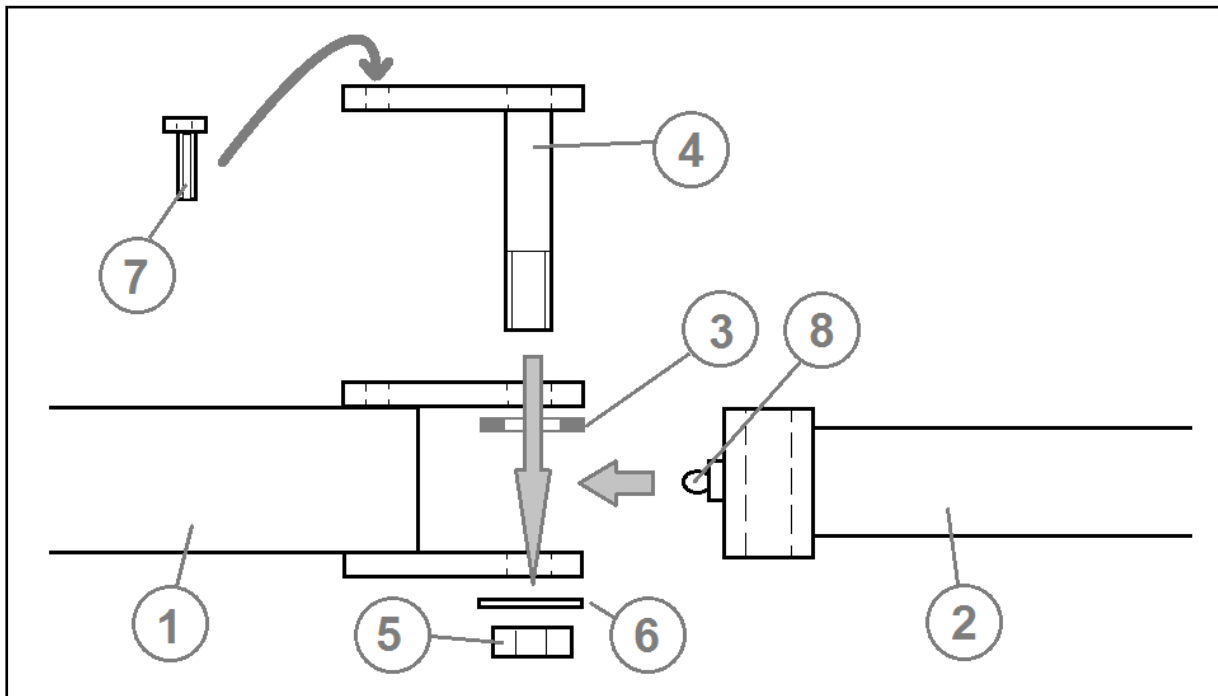

Pos.	Description	Pos.	Description
1	inner wall bracket (mounted at the wall)	5	Nut M24, self-locking
2	outer wall bracket	6	Washer
3	Brake disk	7	Screw M8
4	Joint bolt M24	8	Grease nipple

- The outer wall bracket (2) with its joint sleeve must be set between the fork of the inner wall bracket (1). The brake disc (3) must be positioned between the fork and the joint sleeve.
- Push the joint bolt (4) through the drilled holes of the fork or the joint sleeve. Screw the joint bolt by means of the nut (5) and the washer (6).

i The flexibility of the joint results from the screwing force of the joint bolt and the nut. Set the screwing force - after finishing all assemblies - in a way that the joint is easy to move from the suction hood and that the bracket nevertheless maintains every adjusted position.

- The screw (7) must be mounted to protect the joint bolt (4) from torsion.
- Now grease the joint with lubricant. Therefore, use the grease nipple (8).

5.3. Mounting of the telescope arm

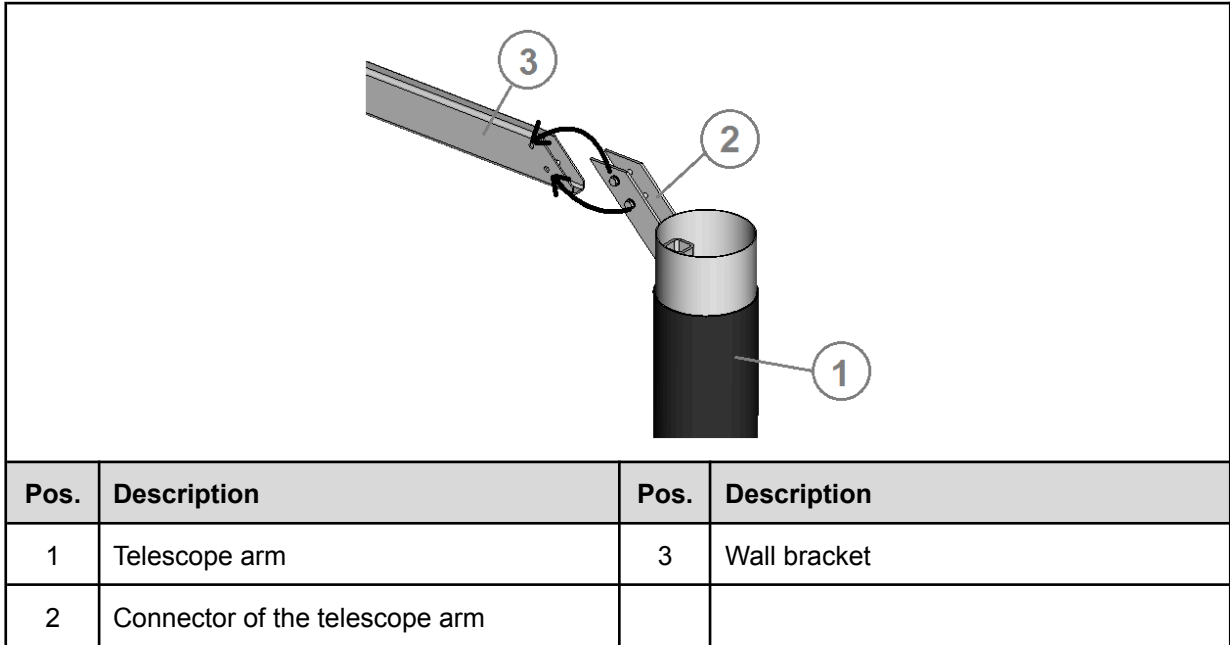

- Mount the connector of the telescope arm (2) at the outer end of the wall bracket (3). Use the supplied screws.

5.4. Mounting the pipe bend

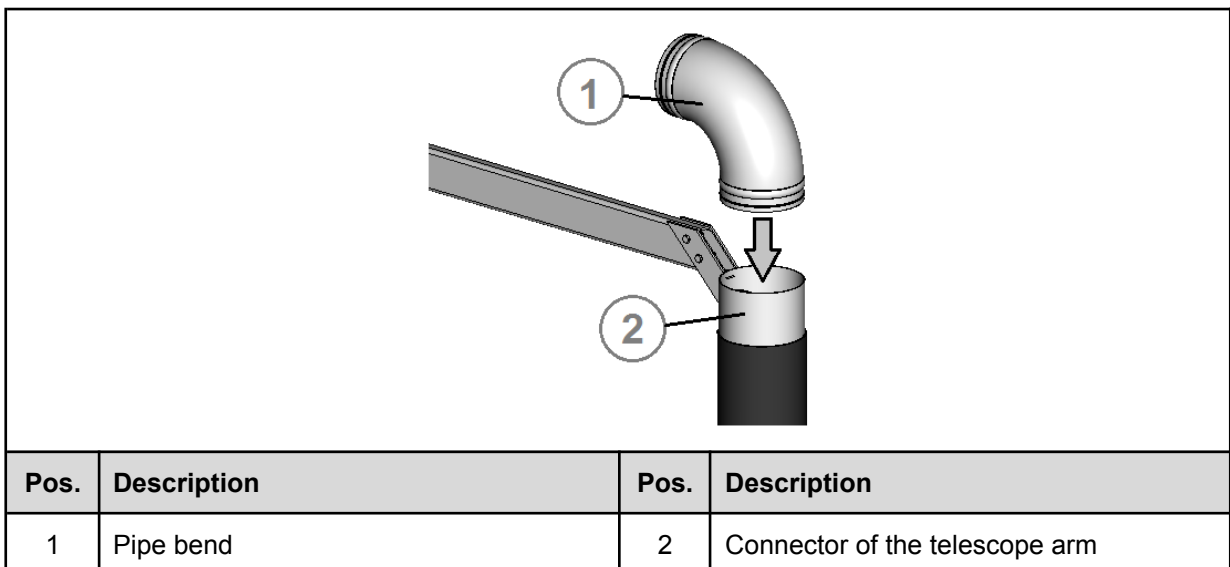

- Insert the elbow pipe (1) into the connector of the telescope arm (2).

5.5. Mounting the pipes on the wall bracket

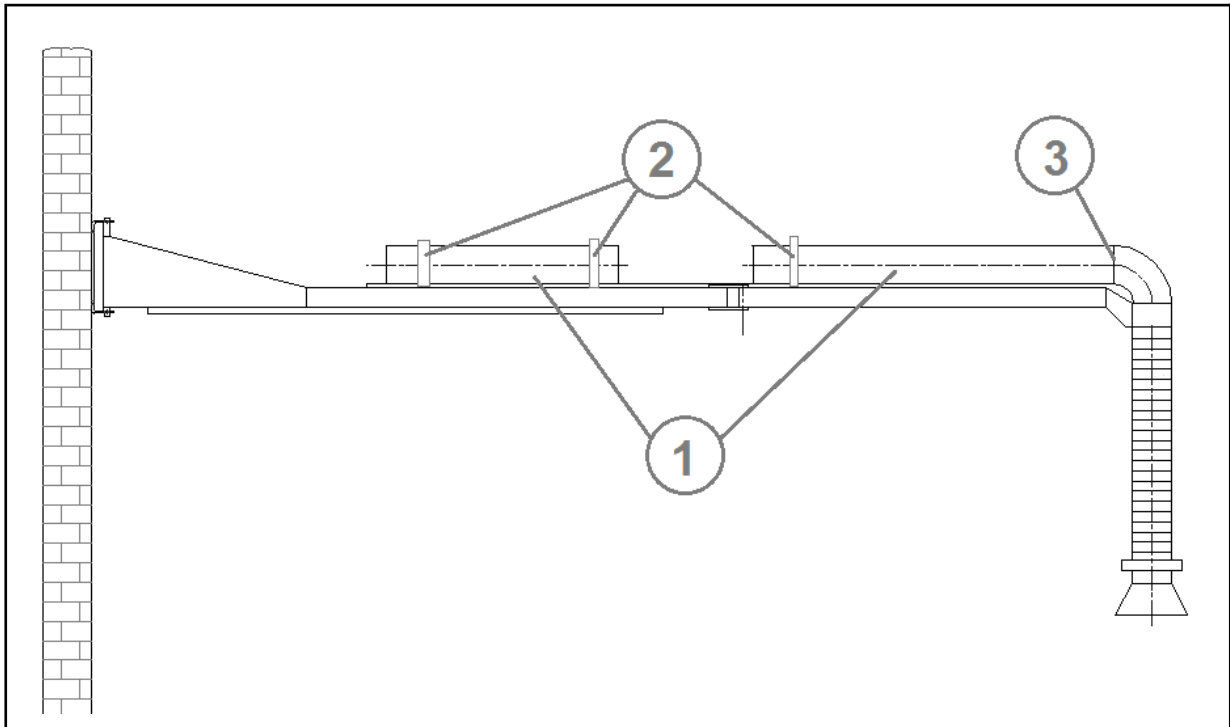

Pos.	Description	Pos.	Description
1	Pipe	3	Connection point pipe / pipe bend
2	Pipe clamp		

- Mount one of the pipes (1) on the inner wall bracket. Therefore, use 2 of the pipe clamps (2).
- Mount the other pipe (1) on the outer wall bracket. Therefore, slip one pipe end over the elbow pipe (3). Attach the other pipe end by means of a pipe clamp (2).

5.6. Mounting the hoses on the wall bracket

NOTICE

Torsion and thereby damage of the hoses is possible.
 The suction crane must be in a stretched position during the assembly of the hoses. This means that the wall bracket is aligned in 90° from the wall and the inner and outer wall bracket are positioned in one line.

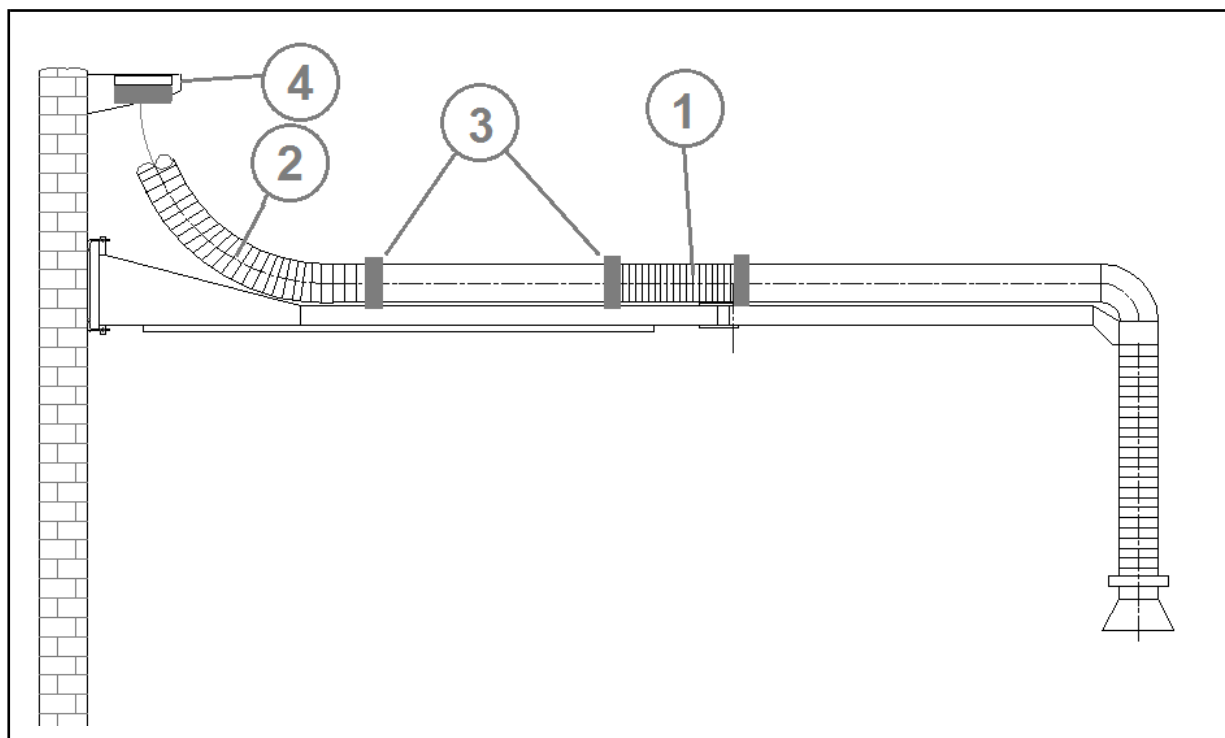



Pos.	Description	Pos.	Description
1	Hose 1,2m	3	Hose clip
2	Hose 1,5m	4	Wall console

- Connect the two pipes to the shorter one (1) of the two hoses. Therefore, push the hose ends on the pipe ends and fix the connections with one hose clip (3) each.
- Connect the wall mount (4) and the pipe to the longer one (2) of the two hoses. Therefore, push the hose ends on the nozzle of the wall mount and on the pipe end and fix the connections with one hose clip (3) each.

6. Maintenance

Regular maintenance work is necessary due to wear caused during operation. It is described in this chapter. Unless otherwise specified by national regulations, we recommend regular visual inspections and functional tests of the device as described in the chapter "Maintenance intervals".

 You find the chapter "Maintenance intervals" at the end of the document. The general maintenance (visual inspection, etc.) is also explained there.

	WARNING
	<p>Working at the suction crane entails the risk of an accidental restarting of the extraction unit.</p> <p>Before carrying out any maintenance or cleaning at the suction crane, the extraction unit connected to the suction crane must be set to maintenance condition first (see chapter "Reset to maintenance state").</p> <p>A re-commissioning of the extraction unit may only be carried out if it is ensured that the suction crane corresponds in its functions to the original state.</p> <hr/> <p>Dangers to life and limb when non-original spare parts are used</p> <p>Only original TEKA spare parts must be used.</p>

6.1. Reset to maintenance state

The extraction unit connected to the suction crane must be set to maintenance condition. Please refer to the instructions in the separate operating manual of the extraction unit.

6.2. Readjusting of the extraction hood

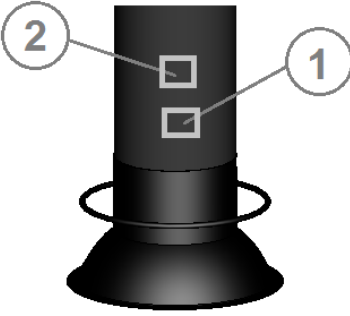

Pos.	Description	Pos.	Description
1	Universal joint	2	Wire fastener for the counterbalance

The suction hood can be swivelled in 2 directions. The suction hood is attached inside the hose by means of a universal joint (1). When the suction hood is hard to move or when the set position is not kept anymore, a readjustment is necessary.

- Loosen the hose clip at the suction hood and lift the hose.
- 2 screw connections with brake discs are attached at the universal joint (1). These control the swivelling in 2 directions. The flexibility can be modified by setting the screwing force.

CAUTION Danger of confusion: above the universal joint there is the attachment of the wire (2) for the counterbalance. This screw connection must not be detached as otherwise the counterbalance falls out of the telescope arm.

- Slip the hose over the end of the suction hood. Attach the hose to the hose clip.

6.3. Readjusting the wall bracket joint

A readjustment is necessary when the wall bracket is hard to move or when the set position is not kept anymore, a readjustment is necessary. The adjustment is described in the chapter “Mounting the outer wall bracket”.

6.4. Relubrication of the wall bracket joint

The joint must be relubricated occasionally. Therefore, use the grease nipple at the wall bracket joint.

6.5. Inspecting the fixing test of the wall console

Regular actions at the suction crane (pulling, pushing, swivelling) also result in strain at the wall console fixing. Screw connections may become loose over time.

- Move the suction crane and look to see whether the wall console also moves.
- Check whether the wall console's screw connections are loose. Re-tighten the screw connections until they are hand tight.
- Also check whether any damage, cracks or similar problems can be observed at the wall or support structure. If in any doubt, it is necessary to fully remount the wall console.

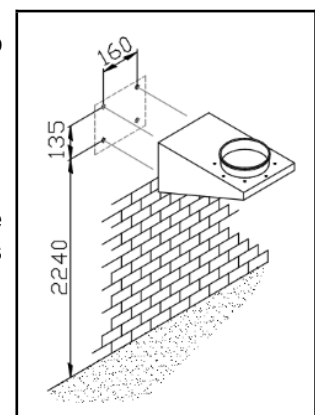

6.6. Inspecting the fixing and functioning of the wall bracket

Regular actions at the suction crane (pulling, pushing, swivelling) also result in strain at the wall bracket fixing. Screw connections may become loose over time.

- Move the suction crane and look to see whether the wall bracket's wall console also moves.
 - Check whether the wall console's (X) screw connections are loose. Re-tighten the screw connections until they are hand tight.
 - Also check whether any damage, cracks or similar problems can be observed at the wall or support structure. If in any doubt, it is necessary to fully remount the wall bracket.
-
- Check whether the joint screw connections of the wall bracket are loose. Re-tighten the screw connections until they are hand tight.

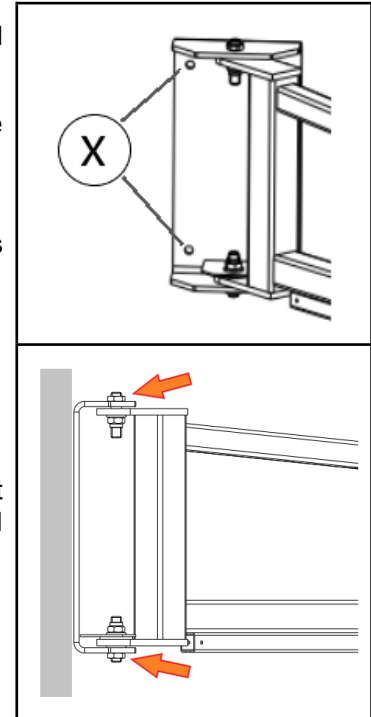

7. Dismantling / Disposal

Only authorised personnel may disassemble the machine.

	CAUTION
<p>Whirling up dust is possible due to the deposited dust. During all work a suitable respiratory protection and protective clothing have to be worn.</p>	

8. Diagnostics and troubleshooting

A list of possible system errors is provided in the table.

A recommissioning of the device must only occur if it is ensured that the system is functionally equivalent to the original state. Repairs may only be carried out by TEKA personnel or, after consultation with TEKA GmbH, by the personnel authorised by the operator.

Adhere to the instructions in the chapter "Safety instructions" and "Maintenance" when carrying out any repairs. If in doubt, contact our TEKA service department:

Tel: +49 2541-84841-0
 E-mail: info@teka.eu

Fault	Cause	Removal
No suction / minimal suction (Smoke/fumes/gases are not extracted at all or only slightly).	Suction crane not connected to the extraction unit.	Connect the suction crane to the extraction unit.
	Damage to the hoses / pipes.	Replace the hoses / pipes.
	Hoses / pipes are restricted / blocked.	Check the suction channel, remove any obstacles that are found.

9. Technical data

Allowed ambient temperature	°C	+5 to +35 (during operations) -10 to +40 (during transport and storage)
Allowed max. humidity	%	70

10. Maintenance intervals

10.1. Usage-related maintenance

The described maintenances become necessary through the demands of the system operations. The maintenance intervals are recommendations. Depending on the application (multi-shift operation, dust generation, ...) it may make sense for the operator to change the intervals of maintenance, replacing and cleaning.

Maintenance work must always be documented by means of a protocol.

The approach of the maintenance measures is described in chapter "Maintenance".

Maintenance work	Chapter	Maintenance interval	
		recommended by TEKA	determined by the operator
Readjusting of the extraction hood / check if a readjustment is necessary	6.2.	monthly	
Readjusting of the wall bracket joint / check if a readjustment is necessary	6.3.	monthly	
Relubrication of the wall bracket joint	6.4.	quarter-annually	
Fixing the wall console	6.5.	annually	
Inspecting the fixing and functioning of the wall bracket	6.6.	annually	

10.2. General maintenance

The described maintenances are independent from the demands of the system operations.

Maintenance work must always be documented by means of a protocol.

Maintenance work	Chapter	Maintenance interval
Visual inspection of the suction crane	10.2.1	weekly

10.2.1. Visual inspection of the suction crane

Visual inspection: Observation that there are no visible safety-related defects.

	WARNING
	Danger arising from the ready to operate condition of the device. Follow the procedure as described in the chapter "Set to maintenance state".

The following steps must be carried out in the course of the visual inspection:

- Check the suction crane for leakages, escaping dust and dust deposits. Dust deposits must be eliminated.
- Check the suction crane for damages. If necessary, replace parts.